

Dry Contact card Quick Reference Manual



Important Note: To avoid potential danger to people and to avoid damage to UPS, the installation must be carried out by qualify technician. Before start the installation, the UPS must be completely shut down and disconnect with AC mains.

1. Dry Contact card installation instruction

Step-1: Remove two screws then remove plastic interface slot cover

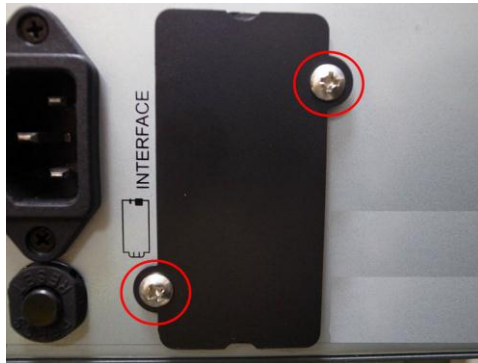

Step-2: Gently slide the Dry Contact card into the interface slot following the guide of interface slot.

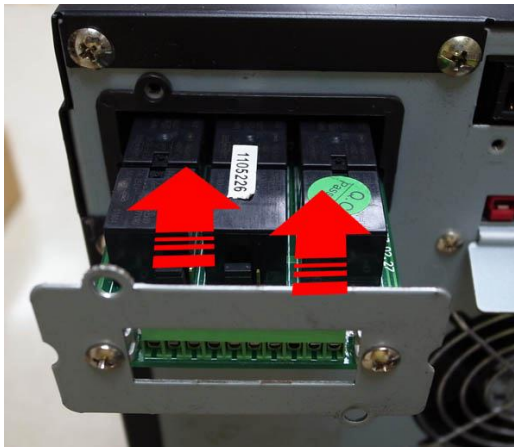

Installation for MSII Series

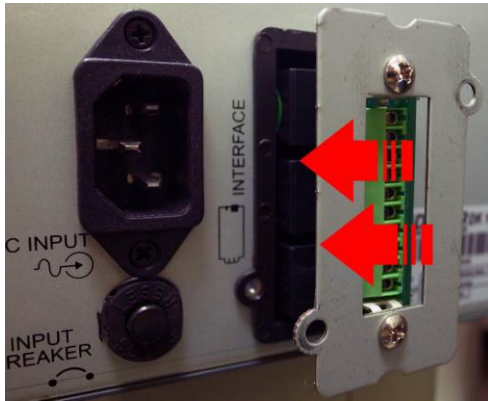

Installation for MSRTPRO Series

Step-3: Install two screws to secure the Dry contact card.

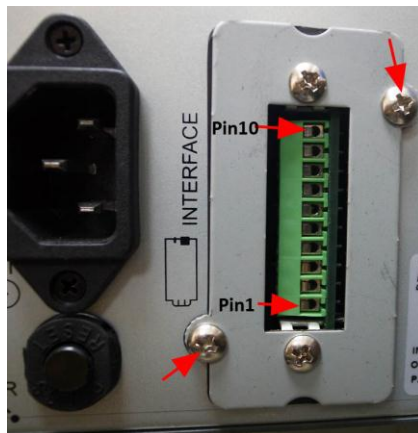
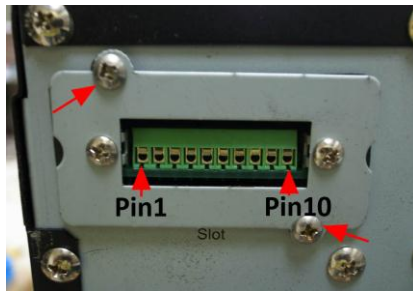

2. Dry Contact card overview

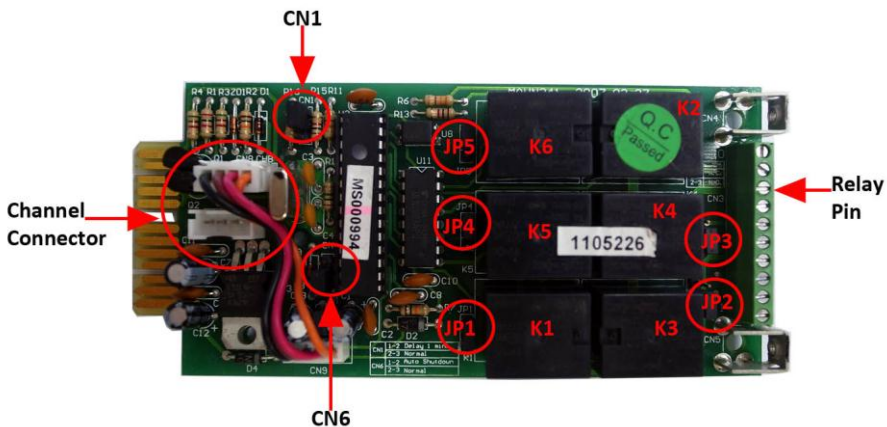

Front view

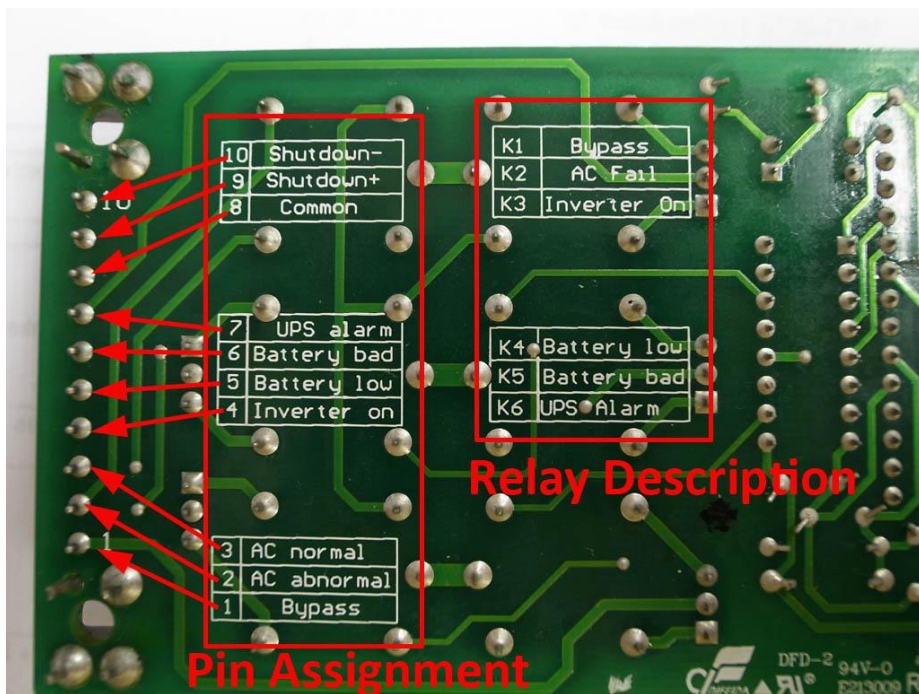

Bottom view

3. Pin Assignment and function description (

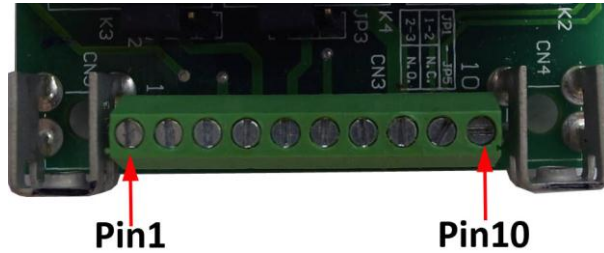

➤ **For Double-Conversion Online UPS: (Continuity)**

Pin 1: UPS on Bypass mode.

Pin 2: Utility Abnormal

Pin 3: Utility Normal

Pin 4: Inverter On

Pin 5: Battery Low

Pin 6: Battery Bad or Abnormal (No function on MS series)

Pin 7: UPS Alarm, it will be triggered when AC fail, UPS with error code or the UPS switch to backup mode.

Pin 8: Common

Pin 9: Shutdown UPS Positive (+) signal

Pin 10: Shutdown UPS Negative (-) signal

➤ **For Line interactive UPS: (Sentra)**

Pin 1: Not Available

Pin 2: Utility Abnormal

Pin 3: Utility Normal

Pin 4: AVR On

Pin 5: Battery Low

Pin 6: Not Available (**No function on MS series**)

Pin 7: Not Available (**No function on MS series**)

Pin 8: Common

Pin 9: Shutdown UPS Positive (+) signal

Pin 10: Shutdown UPS Negative (-) signal

4. Shutdown function

There are two options to shutdown UPS described as following:

➤ Auto shutdown

The shutdown function will be enabled in 1 minute after power failure.

The **pin1-2** of both **CN1** and **CN6** must be shorted for auto shutdown.

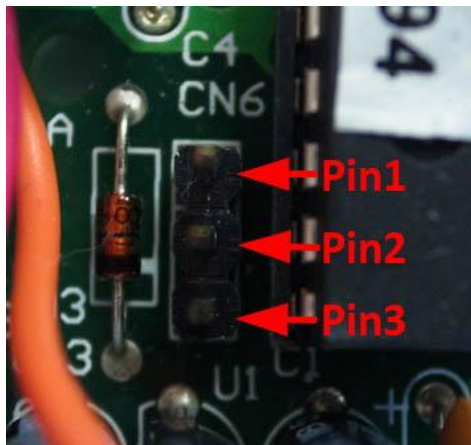

CN1	1-2	Delay 1 min.
	2-3	Normal
CN6	1-2	Auto Shutdown
	2-3	Normal

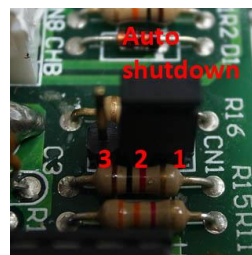

➤ Manual shutdown

The shutdown function will be enabled when the **pin2-3** of both **CN1** and **CN6** shorted by the jumper. The manual shutdown will be activated when supply DC voltage between **+6Vdc to +25Vdc** to the shutdown pin (pin9 and pin10) for 5 seconds.

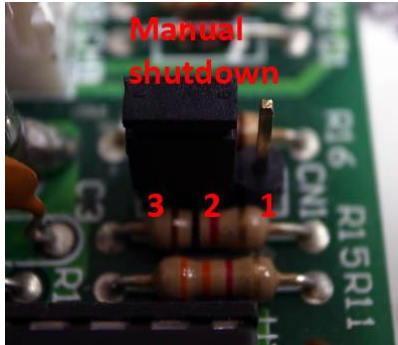

5. Interface card channel setting

The interface card channel setting is required when the UPS come with two interface slots. Two interface cards must be installed with different channel to avoid signal conflict.

The interface card channel setting of Dry Contact card was the connection between CN9 to CN7 or CN8.

- Channel A setting: CN9 to CN7
- Channel B setting: CN9 to CN8

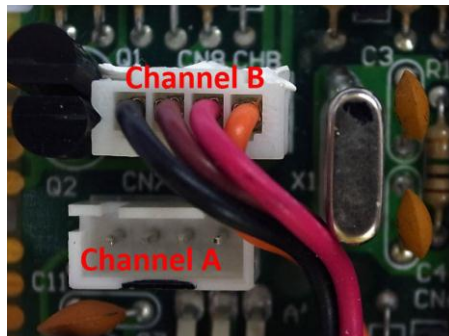

6. Relay description

The Dry Contact card was designed with six relays for different alarms. The capacity of each relay contact is 40Vdc/25mA.

Only relay “K2” was fixed for AC normal/abnormal so there is no jumper for K2 to set N.O or N.C. The rest of relays could be set as normally open or normally close by jumper JP1 to JP5.

The following is the function description for all relays:

- K1: Bypass
- K2: AC Fail

Normally close setting: Pin3 to Pin8 was shorted in normal mode, Pin3 to Pin8 opened when AC Fail.

Normally open setting: Pin2 to Pin8 was opened in normal mode, Pin2 to Pin8 was shorted when AC Fail.

- K3: Inverter On
- K4: Battery low
- K5: Battery bad
- K6: UPS Alarm

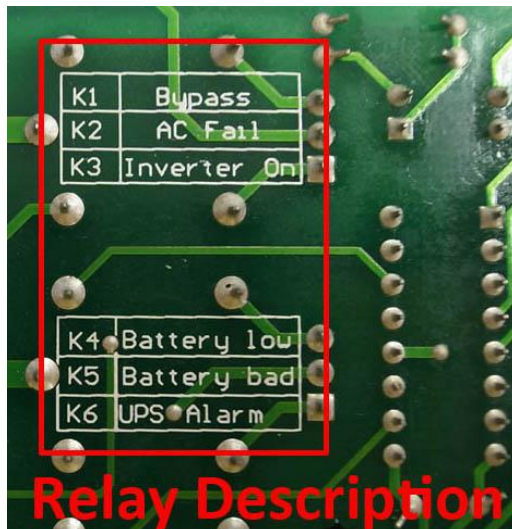

7. Relay settings for normally open and normally close

There are five relays on the Dry Contact card that could be set as normally open or normally close by adjusting the jumper JP1 to JP5 as indicated as following:

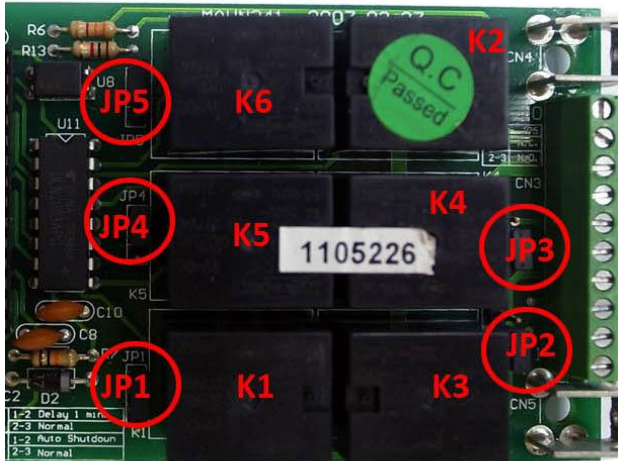

The table below describes the jumper and function for each relay:

Jumper	Relay	Function Description
JP1	K1	Bypass
JP2	K3	Inverter On
JP3	K4	Battery low
JP4	K5	Battery bad
JP5	K6	UPS Alarm

Jumper setting:

- Normally Close: Short pin1 to pin2
- Normally Open: Short pin2 to pin3

The lower pin for each jumper is pin1 and the upper pin is pin3 where indicated as illustration:

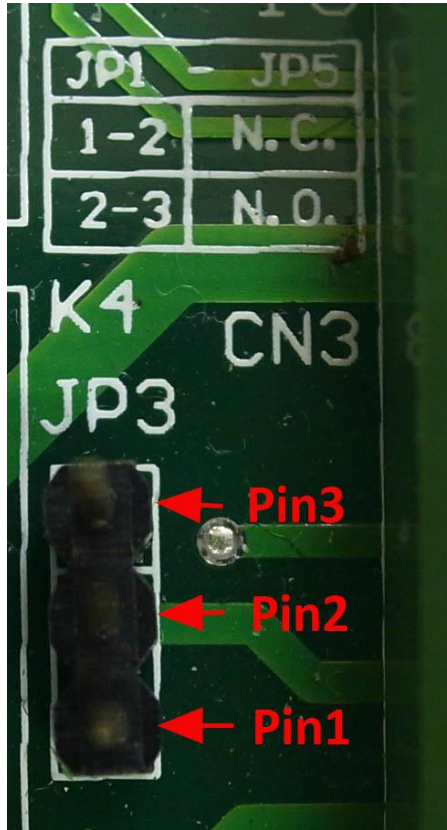

Normally open jumper setting:

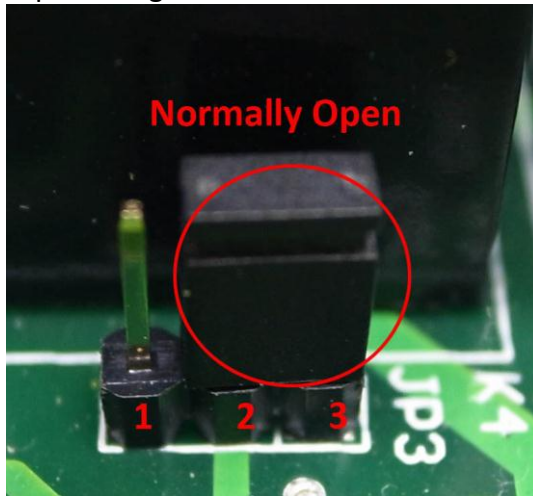

Normally close jumper setting:

